

# Kit 1007

RENAULT Laguna I, 5-dr Hatchback, 94-00

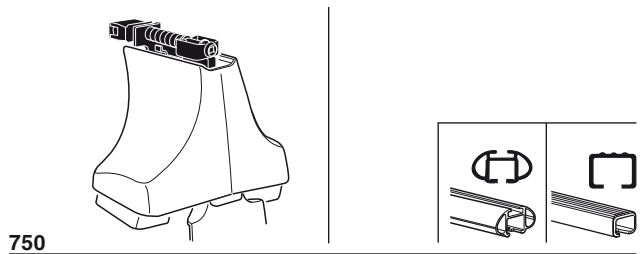
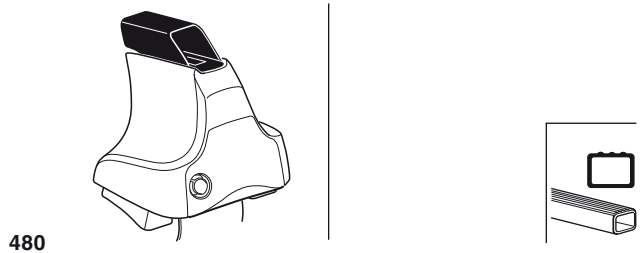
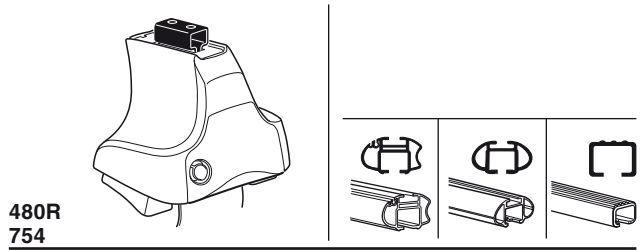

x2	x2	x2	x2	x2
x2	x2	x2	x2	x2
x2	x2	x4	x4	x2
x4		x4		

**Kit**



**3**

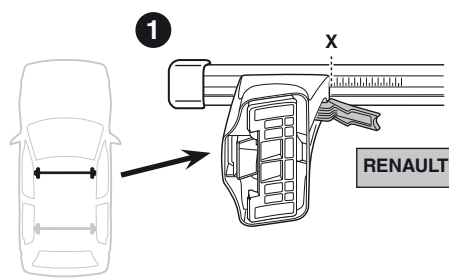
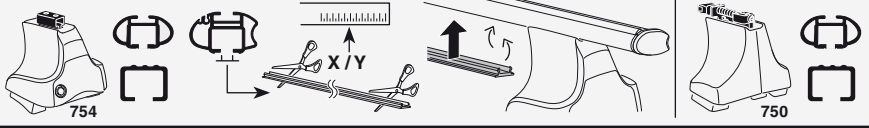

<b>RENAULT Laguna I, 5-dr Hatchback, 94-00</b>	<b>X</b>
	<b>33</b>

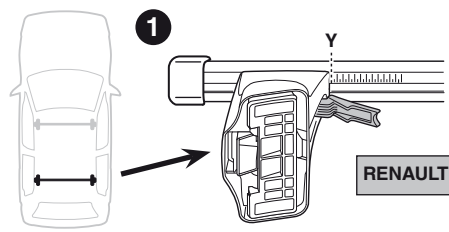
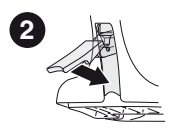

<b>RENAULT Laguna I, 5-dr Hatchback, 94-00</b>	<b>Y</b>
	<b>30,5</b>

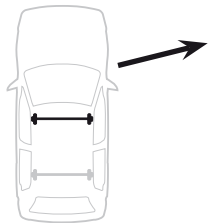
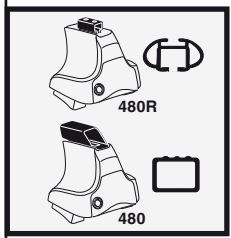
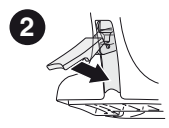

<b>RENAULT Laguna I, 5-dr Hatchback, 94-00</b>	<b>X inch</b>	<b>X mm</b>
	<b>38 5/8"</b>	<b>981 mm</b>

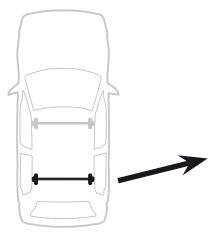
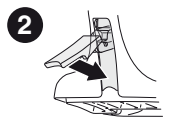
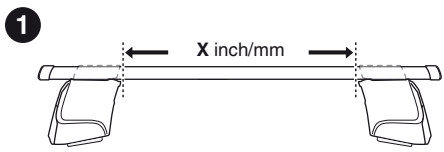

<b>RENAULT Laguna I, 5-dr Hatchback, 94-00</b>	<b>Y inch</b>	<b>Y mm</b>
	<b>37 5/8"</b>	<b>956 mm</b>

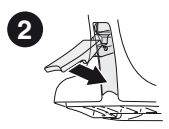
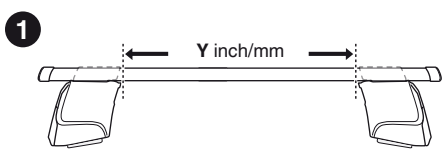

4

RENAULT Laguna I, 5-dr Hatchback, 94-00

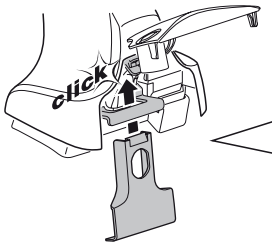
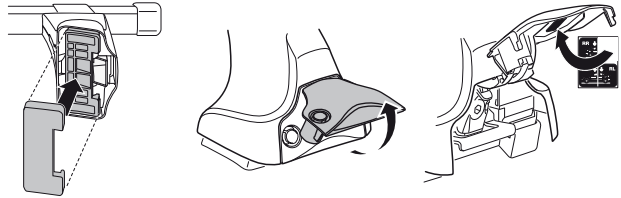
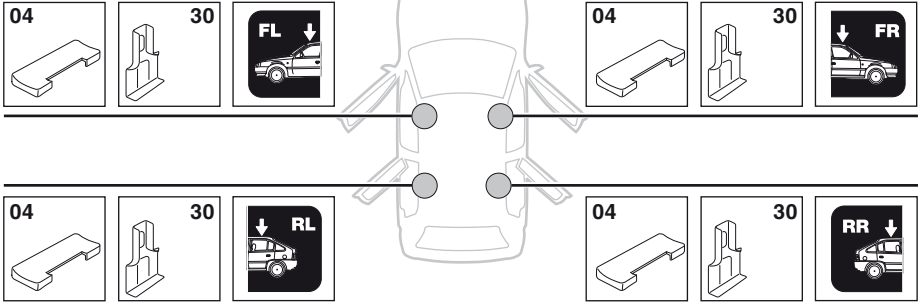

5

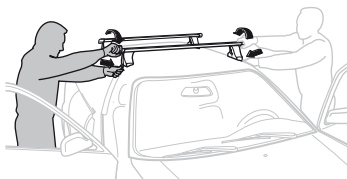
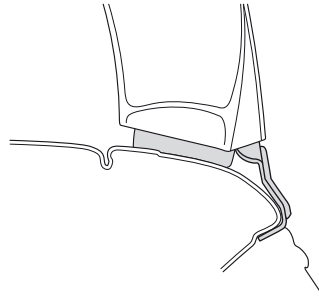
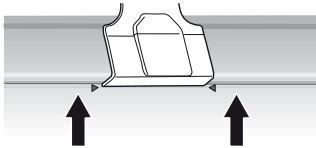
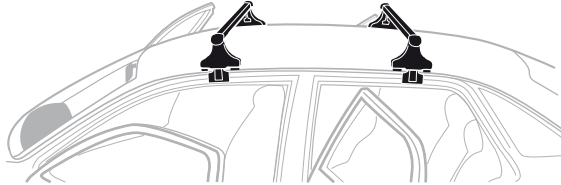

**GB/US** Tighten alternately

**D** Die Schrauben abwechselnd anziehen

**F** Serrer alternativement chaque côté

**NL** Afwisselend aan de linker- en de rechterkant aandraaien

**I** Alternare il serraggio delle viti

**E** Apretar alternativamente

**PT** Aperte alternadamente

**S** Dra åt växelvis

**FIN** Kierrä vuorotellen

**EST** Pinguldage vaheldumisi

**LAT** Pielieciet pamišus

**LIT** Užsukinėkite pakaitomis

**PL** Śruby dokręcaj naprzemiennie

**RU** Затягивайте попеременно

**CZ** Pokręťta багаžníka dokręcaj dokręcaj naprzemiennie.

**SK** Doťahujte striedavo

**SLO** Privijajte izmenično.

**HR** Naizmjenično zategnite

**HU** Egymástól függetlenül szorítandó

**GR** Σφιγγετε εναλλάξ

**TR** Dönüşümlü sıkın

**中文** 交替拧紧

**한국어** 번갈아 가며 조이십시오.

**日本語** 交互に締め付けてください。

**ไทย** ชันโนแบบสลับ

6



480R/754



480

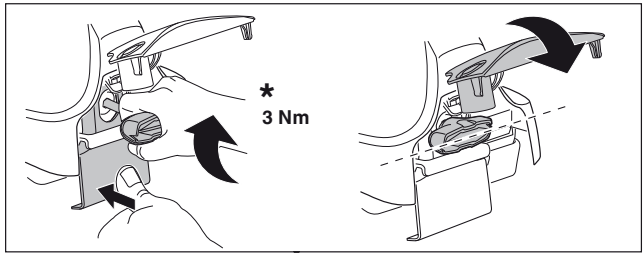
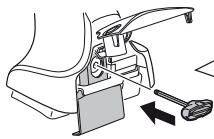

\*  
3 Nm

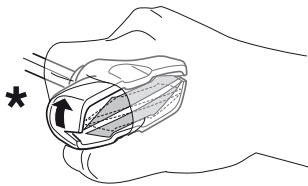

\*

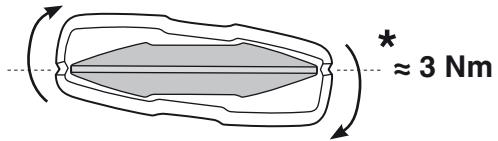

\*  
≈ 3 Nm

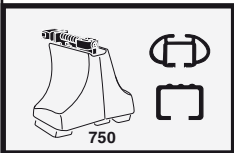
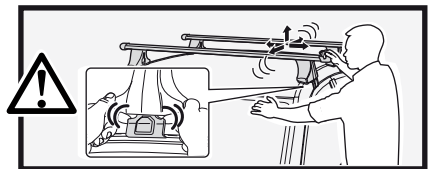

750

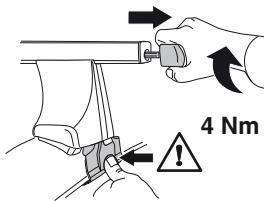

4 Nm

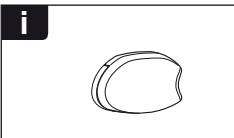
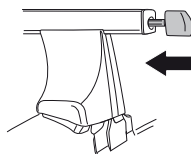

i

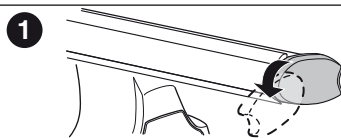

1

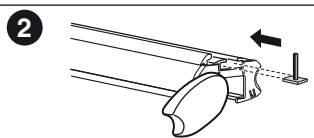

2

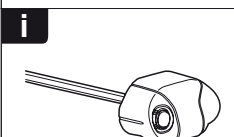

i

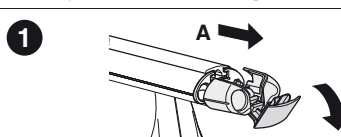

1

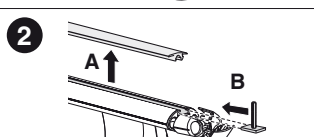

2

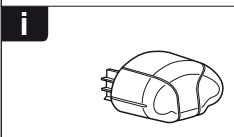

i

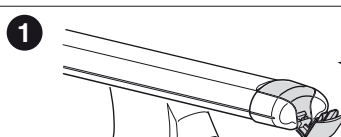

1

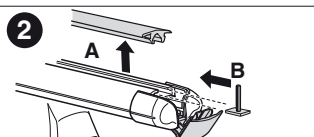

2

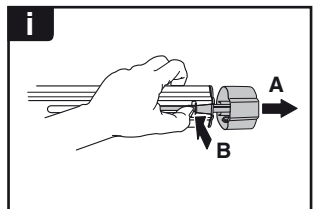
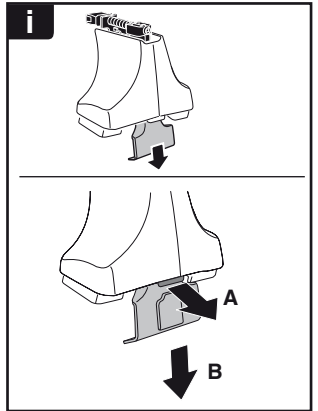
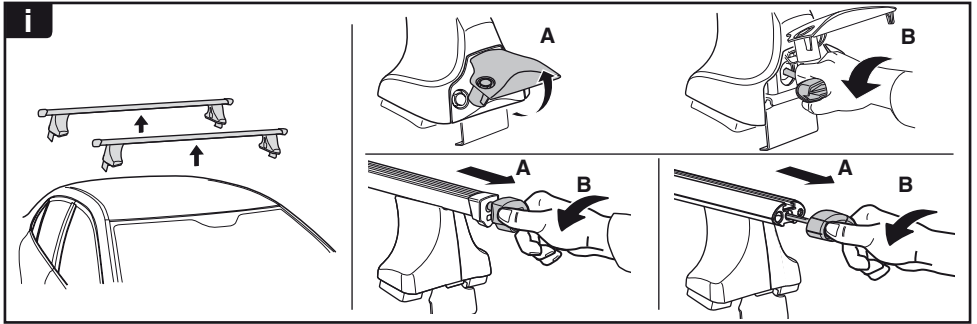

**THULE**  
SWEDEN  
**ONE  
KEY  
SYSTEM**



		(x4)
		(x6)
		(x8)
NA		(x10)
EUR		(x12)
ASIA		(x12)



WW ▶ Thule Sweden AB, Box 69, 330 33 Hillerstorp, SWEDEN  
NA ▶ Thule Inc., 42 Silvermine Road, Seymour, Connecticut 06483, USA

info@thule.com  
customer.service@thule.com

www.thule.com